

Home Security Solutions



25YEAR MECHANICAL WARRANTY

We take the worry out of protecting what's valuable to you.
Lockwood: no worries®

LOCKWOOD
ASSA ABLOY

Contents

Nero® Collection

143 Entrance Handle	4
Paradigm® 005 Double Cylinder Deadbolt	5
Nexion® Mechanical Entrance Lockset	6
Velocity® Large Rose Series Element Lever	7
Velocity® Small Rose Series Leversets	9
Cavity Sliding Door Lock	13
FP2 Flush Pull	14

Entrance Solutions

Velocity® Entrance Lockset	17
Nexion® Mechanical Entrance Lockset	18
Paradigm® 005 Double Cylinder Deadbolt	20
Symmetry Deadbolts	21
001® Double Cylinder Deadlatch	22
Deadlocks	23
Paradigm® Pull Handle Lockset	24
Entrance Handles	26

Interior Solutions

Velocity® Series Door Lever Handles	30
Symmetry Door Handle Range	32

Sliding Door Solutions

Outland Sliding Door Track	35
Cavity Sliding Door Locks	36
Patio Sliding Door Lock	37
Hinged & Sliding Security Screen Door Locks	38



Nero[®] Collection

NERO[®]
COLLECTION

143 Entrance Handle



Make a statement with the Lockwood 143 Entrance Handle; constructed using the finest materials to incorporate the maximum standards in durability, finish and design.

Suited to both residential and commercial applications, this handle is supplied with spigots to suit 10 – 12mm thick glass doors as well as aluminium and timber doors up to 50mm thick.

Features

- Constructed of 304 grade stainless steel
- Suitable for use in both internal and external environments



143X600MBK

Paradigm® 005 Double Cylinder Deadbolt



The Paradigm 005 Double Cylinder Deadbolt is the premium security solution with its innovative safety features. Its contemporary styling can be combined with the entrance handle and leversets in the Nero® range to create an elegant look to any front door.

Features

- Three function modes with DualSelect® provides perfect combination of convenience and security
- High security cut resistant stainless steel bolt
- Safety Release™ automatically unlocks internal knob upon key entry from outside
- LockAlert® indicator shows lock status at a glance
- Available in round and square rose



005/B1MBKDP



005/B1MBKDP



005/B2MBKDP



005/B2MBKDP

Nexion[®] Mechanical Entrance Lockset



The Lockwood Nexion Mechanical Entrance Lockset represents the next generation in home security.

Designed and manufactured to the highest quality standard, the Lockwood Nexion range has set the benchmark for safety, security and style. The Nexion range of deadlatches offers the ultimate protection for your home and family.

Features

- SafetyRelease™ automatically unlocks the inside handle upon entry to minimise the risk of being locked in
- LockAlert® indicator shows lock status at a glance
- Three modes of security: Secure, Safety and Passage mode provides excellent security without compromising convenience
- Designed to be keyed to builder's key systems as well as keyed alike to other Lockwood door locks
- Conforms to Australian Standard AS4145.2-2008 S,7D8C5K6



NXV12/1L3MBK

NXV12/1L3MBK

Velocity® Large Rose Series Element Lever



Be confident with a design that transcends the basic functional and aesthetic requirements of residential hardware.

Setting the benchmark in ease of installation, the Lockwood Velocity leverset is supplied pre-assembled with no loose screws or spindles. Screws align through the rose removing the need to locate them blind through the door. A twist and a quick tightening of the screws and the levers are installed!

Featuring a 63mm round rose or 66.5mm square rose, the Nero® Velocity Large Rose Series is suitable for retrofit and common residential door preparations.

Features

- All fixings are concealed beneath a removable rose trim providing a crisp and clean presentation desired by the discerning home owner
- Simple twist and tighten fixing method with pre-assembled lever set allows for super easy and fast installation
- Available in a choice of square or round rose with the Element lever design
- Designed in Australia for the specific needs of the Australian market

Rose Dimensions

63mm by 12.5mm - Round Rose

65mm by 12.5mm - Square Rose

Velocity® Large Rose Series Element Lever



Round Rose Passage Set
VEL1/L3MBK
63mm Round Rose



Round Rose Privacy Set
VEL2/L3MBK
63mm Round Rose



Round Rose Dummy Handle
VEL3/L3MBK
63mm Round Rose



Square Rose Passage Set
VEL1/L3MBK + VES1-TRIMMBK
65mm Square Rose



Square Rose Privacy Set
VEL2/L3MBK + VES2-TRIMMBK
65mm Square Rose

Velocity® Small Rose Series Leversets



Capture the aesthetic tone of on trend design whilst maintaining utilitarian desire with the Nero® Velocity Small Rose Series.

Designed for semi-commercial and residential applications, this range can be used with commercial mortice locks in addition to having passage, privacy and dummy leversets.

Features

- All fixings are concealed beneath a removable rose trim providing a crisp and clean presentation desired by the discerning home owner
- Simple twist and tighten fixing method with pre-assembled lever set allows for super easy and fast installation
- Choose from two lever designs, the ever popular Element L3 lever and the AS1428.1 compliant Dianella L8 lever
- Available in a choice of square or round rose
- Successfully tested up to 2 hours on fire door assemblies with the Australian Standard AS1905.1 2005 - Part 1: Fire Resistant Doorsets when used with Lockwood Synergy or Selector mortice locks
- Includes range of escutcheons such as a AS1428.1 compliant turnknob, standard turnknob and privacy indicating emergency turn.

Rose Dimensions

55mm by 12.5mm - Round Rose

58mm by 12.5mm - Square Rose

Velocity® Small Rose Series Leversets



Round Rose Mortice Set
VSR0/L3MBK
55mm Round Rose



Round Rose Passage Set
VSR1/L3MBK
55mm Round Rose



Round Rose Privacy Set
VSR2/L3MBK
55mm Round Rose



Round Rose Dummy Handle
VSR3/L3MBK
55mm Round Rose

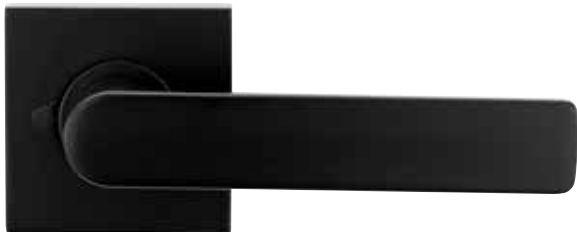

Square Rose Passage Set
VSR1/L3MBK + VSS1-TRIMMBK
58mm Square Rose



Square Rose Privacy Set
VSR2/L3MBK + VSS2-TRIMMBK
58mm Square Rose

Velocity® Small Rose Series Leversets



Round Rose Mortice Set
VSR0/L3MBK
55mm Round Rose



Round Rose Passage Set
VSR1/L8MBK
55mm Round Rose



Round Rose Privacy Set
VSR2/L8MBK
55mm Round Rose



Round Rose Dummy Handle
VSR3/L8MBK
55mm Round Rose



Square Rose Passage Set
VSR1/L8MBK + VSS1-TIMMBK
58mm Square Rose



Square Rose Privacy Set
VSR2/L8MBK + VSS2-TRIMMBK
58mm Square Rose

Velocity® Small Rose Series Escutcheons



Euro Profile Cylinder Escutcheon
VSR5/MBK
55mm Round Escutcheon



Oval Cylinder Escutcheon
VSR6/MBK
55mm Round Escutcheon



Standard Turnknob
VSR7/MBK
55mm Round Escutcheon



Privacy Indicating Emergency Turn
VSR8/MBK
55mm Round Escutcheon



Disabled Accessible Turnknob
VSR9/MBK
55mm Round Escutcheon

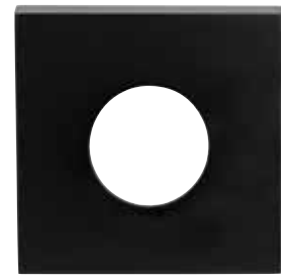

Square Rose Escutcheon Trim
VSS6-TRIMBK
58mm Square Escutcheon

Cavity Sliding Door Lock



Combining elegance and ease of use, the Lockwood Cavity Sliding Door Lock provides a subtle sophistication and innovative solution for all your sliding door needs.

Features

- Fitted flush against the panel of the sliding door for full recess into the door cavity
- Available in Entrance, Privacy and Passage sets as shown
- Retractable Door Pull for ease of use

Privacy Set



Exterior View
7400MBKDP

Interior View
7400MBKDP

Entrance Set



Exterior View
7444MBKDP

Interior View
7444MBKDP

Passage Set



Exterior View
7450MBKDP

Interior View
7450MBKDP

FP2 Flush Pull



Providing minimalist perfection, the Lockwood Nero® Flush Pull is suited for numerous applications which require the door furniture to be flush with the surface of the door.

Feature

- Fitted flush against the panel of the sliding door for full recess into the door cavity



Flush Pull
FP2-150PC

Entrance Solutions

Velocity®
Entrance Lockset





Exterior View



Interior View

The Lockwood Velocity Entrance Lockset is the latest development in the Entrance Lockset range. Designed and manufactured to Australian Standards, the Velocity Entrance Lockset provides a simple and functional entrance lock to complement the Velocity Door Handle range.

Features

- High security latch
- Box strike with concealed crossgrain door frame strengthening screw
- Installation template included
- Can be keyed alike to other Lockwood door locks
- Retrofittable

Quick Installation

Easy installation, retrofits most common front door preparations.

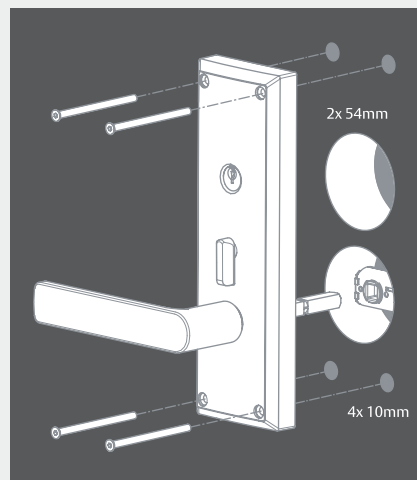

Nexion® Mechanical
Entrance Lockset



Lever Selection



Summit® - L1



Spire® - L2



Element™ - L3



Glide™ - L4



Hakea® - 28



Saltbush® - 34

The Lockwood Nexion Mechanical Entry Locksets represent the next generation in home security.

Designed and manufactured to the highest quality standard, the Lockwood Nexion range has set the benchmark for safety, security and style. The Nexion range of deadlatches offers the ultimate protection for your home and family.

The Nexion Mechanical Entry Lockset is available in two different plate styles and a range of lever styles, allowing you to achieve a consistent style throughout your home.

Features

- SafetyRelease™ automatically unlocks the inside handle upon entry to minimise the risk of being locked in
- Lockout Release automatically unlocks the outside handle when the inside handle or snib is operated
- Factory set for left hand opening doors, easily changed for right hand opening doors.
- Can be keyed alike with other Lockwood door locks
- Conforms to Australian Standard AS4145.2-2008 S_i7D8C5K6

Paradigm® 005 Double Cylinder Deadbolt



The Lockwood high security deadbolt range offers exceptional safety and security for your home and family.

With the unique, patented LockAlert® and SafetyRelease™ functions, this is the pinnacle in deadbolt security products.

Available in either a round or square rose, with a selection of 5 different finishes including Stainless Steel, the Lockwood 005 Deadbolt is ideally suited for use with the Lockwood range of Door and Entrance Handles.

Features

- Three function modes with DualSelect® provides perfect combination of convenience and security
- High security cut resistant stainless steel bolt
- Safety Release™ automatically unlocks internal knob upon key entry from outside
- LockAlert® indicator shows lock status at a glance

Round Rose



Exterior View



Interior View

Square Rose



Exterior View



Interior View

Symmetry Deadbolts



The Lockwood entry-level deadbolt offers standard security for your home.

Available in a single or double cylinder configuration and range of finishes, the Symmetry Deadbolt is ideally suited to compliment Lockwood Key in Knob and Key in Lever locksets.

Features

- Suits left or right hand opening doors
- Solid brass bolt with 25mm projection
- Hardened insert in locking bolt

Double Cylinder



Interior View



Exterior View

Single Cylinder



Interior View



Exterior View

001[®] Double Cylinder Deadlatch



The iconic Lockwood 001 Deadlatch offers market-leading performance and reliability for your home. Featuring unique, patented LockAlert[®] and SafetyRelease[™] functions, the 001 Deadlatch offers supreme safety for you and your family.

Features

- Conforms to the security and durability requirements of Australian Standard AS4145.2-2008 | S17D8C6
- Cut-resistant Stainless Steel Bolt
- 11 concealed anchorage points and a door frame strengthener that combine to offer high security protection
- Hold back function that allows you to use the door in passage mode



Interior View



Exterior View



Interior View, with Lever

Deadlocks



The 303 Single Cylinder Deadlock and 355 Double Cylinder Deadlock suits inward opening, and some sliding doors of 30-45mm thickness.

Both the 303 Single Cylinder Deadlock and 355 Double Cylinder Deadlock can be opened by key from outside and by turn knob from inside. Each feature concealed fixings for superior anchorage and security.

Suitable door types include: single hinged door, single sliding door, pair timber hinged doors and pair timber sliding doors. Glazed doors require minimum side rail.

Security

Conforms to Australian Standard AS4145.2-2008 SL7D8C6.

303 Single Cylinder Deadlock



Exterior View



Interior View

355 Single Cylinder Deadlock



Exterior View



Interior View

Paradigm® Pull Handle Lockset



The Australian designed Paradigm Pull Handle Lockset expresses superior state-of-the-art design featuring a contemporary style that delivers exceptional safety and security. The Paradigm Pull Handle lockset is available in Double Cylinder Deadbolt, Single/Double Cylinder Deadlatch variants.

The Deadbolt lockset is suitable for residential, new building and renovation applications whereas, the Single and Double Cylinder Deadlatch locksets are specifically designed for semi-commercial and apartment buildings. Both Single and Double Cylinder Deadlatch variants have been successfully tested up to 2 hours (depending on the type of doorset) on fire assemblies in accordance with Australian Standard AS1905.1-2005, part 1: Fire Resistant Doorset for commercial applications.

Incorporating innovative features from the 005 Paradigm Deadbolt, the Pull Handle is manufactured with high end 304 grade stainless steel that comes in a brushed satin finish, further enhancing the style.

Features

- Conforms to the security and durability requirements of Australian Standard AS4145.2-2008 | S:8D8C6K5
- High security cut resistant Stainless Steel bolt/latch
- Door Magnets included to hold the door(s) in position when it is in passage mode (Deadbolt version only)
- Concealed screw fixings provide a neat and clean appearance



Exterior

*Interior
Double Cylinder -
Deadbolt*

*Interior
Single Cylinder -
Deadlatch*

*Exterior / Interior
Dummy*

Entrance Handles



Lockwood Entrance Handles are constructed using the finest materials to incorporate the maximum standards in style, durability, finish and design.

Stainless Steel Construction

Constructed of 304 grade stainless steel, Lockwood Entrance Handles are suitable for use in external environments.



151
300x200mm



231
300x140mm



141
300x40mm



142
300x32mm

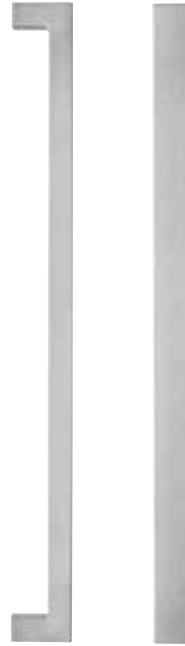

143
300x30mm

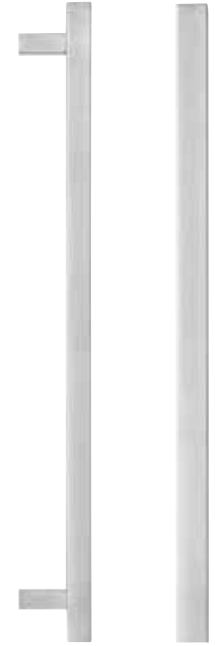

145
225x25mm

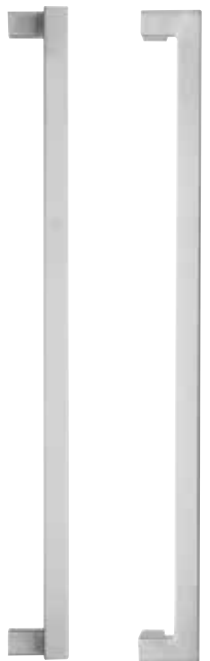

146
450x60mm



147
450x19mm



192
450x85mm



005*

* Refer to page 23 for additional information on the Paradigm® Pull Handle Lockset

Interior Solutions



*Outland Sliding Door Track and
FP2 Flush Pull (Nero Collection)*

Velocity® Series Door Lever Handles



63mm Rose, Saltbush® 34 Lever in Chrome Plate



The Lockwood Velocity Series Door Handles offer an exceptional level of quality that is synonymous with the Lockwood brand.

Available in two different rose sizes with a range of finishes and a selection of stylish lever options.

All fixings are concealed beneath the removable rose trim providing a crisp and clean presentation.

Achieve consistent styling throughout your home by matching your internal door handles with your selected Lockwood external lock.

Rose Dimensions

63mm by 12.5mm - Round Rose
65mm by 12.5mm - Square Rose

Quick Installation

The frustration of fiddling with small parts or misplacing them during installation is a thing of the past. The Velocity range of lever sets are supplied pre-assembled so there are no loose screws or spindles.

Screws align through the rose removing the need to locate them blind through the door. A twist and a quick tighten of screws and the levers are installed.

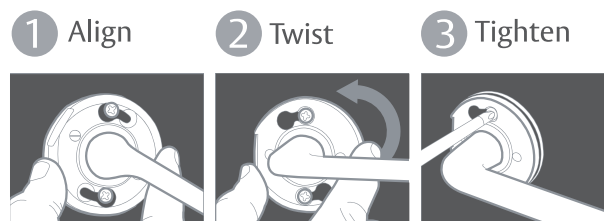

Velocity® Large Round Rose Leversets

The Large Rose of 63mm is the ideal size for replacing existing handles, and covering paint lines on doors.



Summit® - L1



Spire® - L2



Element™ - L3



Glide™ - L4



Hakea® - 28



Saltbush® - 34

Velocity® Small Round & Square Rose Leversets

The Small Rose is designed primarily for new installations and is available in Round Rose of 55mm or Square Rose of 58mm.



Summit® - L1 | Round



Spire® - L2 | Round



Element™ - L3 | Round



Glide™ - L4 | Round



Dianella™ - L8 | Round

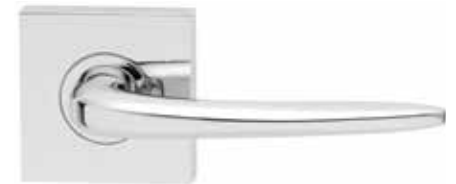

Summit® - L1 | Square



Spire® - L2 | Square



Element™ - L3 | Square



Glide™ - L4 | Square

Symmetry Door Handle Range



Vicinity Entrance Leverset, Chrome Plate

Symmetry Series Key in Knob and Key in Lever Locksets are suitable for left or right handed doors and can be keyed alike to other Lockwood door locks.

Symmetry Entrance sets are ideally suited for use with Lockwood Symmetry Deadbolts and are also available in Passage, Privacy and Dummy versions to create a consistent style throughout your home.

Symmetry Knobsets



Manor Entrance Knobset



Manor Privacy Knobset



Manor Passage Knobset



Imperial Entrance Knobset



Imperial Privacy Knobset



Imperial Passage Knobset

Symmetry Leversets



District Entrance Leverset



District Privacy Leverset



District Passage Leverset



Vicinity Entrance Leverset



Vicinity Privacy Leverset



Vicinity Passage Leverset

Sliding Door Solutions

Outland Sliding Door Track



The Lockwood Outland Sliding Door Track incorporates industrial design with the highest standards of quality. The Outland offers a classic barn door look with exposed steel straps that wrap beautifully around the nylon wheels; running smoothly along a flatbar track.

Features

- Easy to install, perfect for DIY installations
- High quality powder coat finish provides excellent durability
- Quiet operation with nylon bearing wheels

Cavity Sliding Door Locks



Combining elegance and ease of use, the Lockwood Cavity Sliding Door Lock provides a subtle sophistication and innovative solution for all your sliding door needs.

Features

- Fitted flush against the panel of the sliding door for full recess into the door cavity
- The Nero version is only available in Privacy version but SP and CP finishes are available in all versions
- Retractable Door Pull for ease of use

Entrance Set



Passage Latch Set



Privacy Set



Passage Set



Patio Sliding Door Lock



The Lockwood Onyx range incorporates advanced security and safety features making this product the ideal choice for sliding patio door applications.

Onyx is further enhanced by the intuitive operation of the unique sliding snib and the innovative LockAlert® feature that indicates the lock status at a glance.

Features

- Twin locking beaks for added security
- Door Close Detect button (DCD) anti slam feature protects locking beaks from accidental damage
- LockAlert® indicator shows lockset status at a glance
- DualSelect® enables two stage key locking
- Safety Release™ function minimises the risk of being locked in
- Ergonomic sliding snib with intuitive downward motion to unlock



D Inner Handle



Slim Inner Pull



Slim Outer Pull



Universal Strike

Hinged & Sliding Security Screen Door Locks



The Lockwood range of Security Door Locks are designed to suit the standard 20mm hinged or sliding security door.

Both versions feature the unique DualSelect® functionality and are self-latching for improved home security.

Confirms to Australian Standard AS4145.2 2008, offering exceptional performance and reliability.

Features

- Lock from inside using snib
- Two keys available and can be keyed alike to other Lockwood door locks
- Suits left and right handed doors
- Available in a range of finishes



Inside



Inside

The 8653 Sliding Security Door Lock includes a **LockAlert®** indicator which shows the lock's status at a glance.



ASSA ABLOY

Lockwood is the leading brand in the Australian locking industry. With an established reputation for high quality products, this iconic brand provides a wide range of locking solutions to residential housing, commercial, semi-commercial, building and industrial application markets. Lockwood is supported by an extensive distribution and after-sales support network. Our customers include retailers, architects, trade and industrial personnel, locksmiths and security dealers.

ASSA ABLOY is the global leader in door opening solutions, dedicated to satisfying end-user needs for security, safety and convenience.

ASSA ABLOY is represented in all major regions, in both mature and emerging markets, with leading positions in Australia, Europe and North America.

**25YEAR
MECHANICAL
WARRANTY**

The Lockwood 25 Year Mechanical Warranty

Our belief that we manufacture the finest premium products available in today's market place is backed by the Lockwood 25 Year Mechanical Warranty, ensuring that Lockwood continues to keep Australians safe by delivering security and peace of mind.

For warranty terms and conditions, please visit www.lockweb.com.au or call **1300WARRANTY**

ASSA ABLOY Australia Pty Ltd
235 Huntingdale Road
Oakleigh, Victoria, 3166
Australia

1300 LOCK UP (1300 562 587)
lockweb.com.au

ASSA ABLOY New Zealand Ltd
6 Armstrong Road
Albany, Auckland, 0632
New Zealand

@assaabloy.com
Telephone +64 9415 7111
assaabloy.co.nz

Disclaimer

Whilst every effort has been made to ensure that the information (including product images and drawings) contained in this brochure is accurate at the time of publication, ASSA ABLOY Australia Pty Limited ("ASSA ABLOY") recommends that you consult ASSA ABLOY or its agents prior to placing an order to ascertain current information on specific products, as ASSA ABLOY reserves the right to make changes without notice. ASSA ABLOY will not be liable for any injury, loss or damage whatsoever, arising from any errors or omissions in the information contained in the brochure or arising from the use or application of the information contained herein. © 2018 copyright by ASSA ABLOY All rights reserved

